

Osby Parca EL 160 Eco II

– A new generation of electric boilers 72-156 kW

The Professional's Choice Since 1935

This is why you should choose an electric boiler in the Eco series:

- ✓ **RELIABLE** and modern
- ✓ Easy-to-handle control via **TOUCHSCREEN**
- ✓ Operating information and alarm with **TROUBLESHOOTING TEXT**
- ✓ Backup via USB
- ✓ **CIRCUIT BREAKER** as standard
- ✓ Automatic **RESTART** in case of power failure
- ✓ Eco represents 100 % **SWEDISH QUALITY** and low maintenance costs.
- ✓ Integrated internet module makes communication via **MODBUS** possible
- ✓ Alerts via **BMS SYSTEM** or relay output
- ✓ Available in two versions; with or without **BUILT-IN SAFETY EQUIPMENT**
- ✓ Electric boilers with built-in safety equipment are an affordable alternative for compliance with **EN 12828**

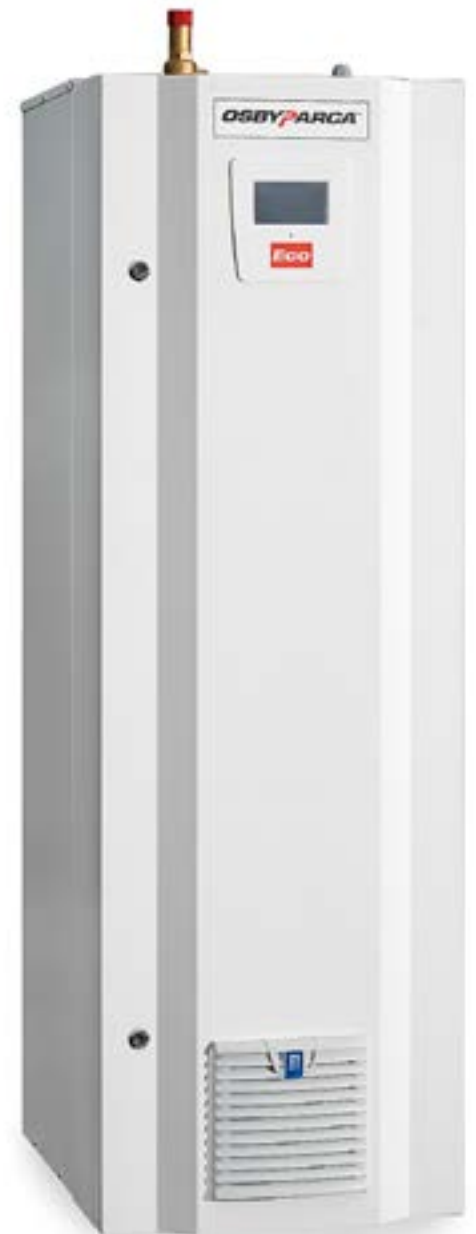



Osby Parca Electric Boilers Eco

Smart electric boilers 36 - 504 kW



Electric boilers with modern equipment

Our improved electric boilers have a design which offers a modern and sleek impression. The control system with touchscreen is clear and user-friendly, and enables the property caretaker to monitor the boiler and its servicing intervals.

The boiler is easier to install and the safety equipment has been modernized, including a new pressure transmitter.

Functions

The control system with touchscreen allows simple operation and start-up. It also allows individual functions to be monitored according to each customer's needs. The overview of the boiler's parameters is convenient and easy to understand. For example, it is possible to view boiler output in addition to temperature.

Connection to external equipment, such as integration/control from a heat pump, is easy. For outdoor temperature compensation one only need a separate outdoor temperature sensor.

All parameters are accessible via Modbus and the boiler also has a integrated internet module.

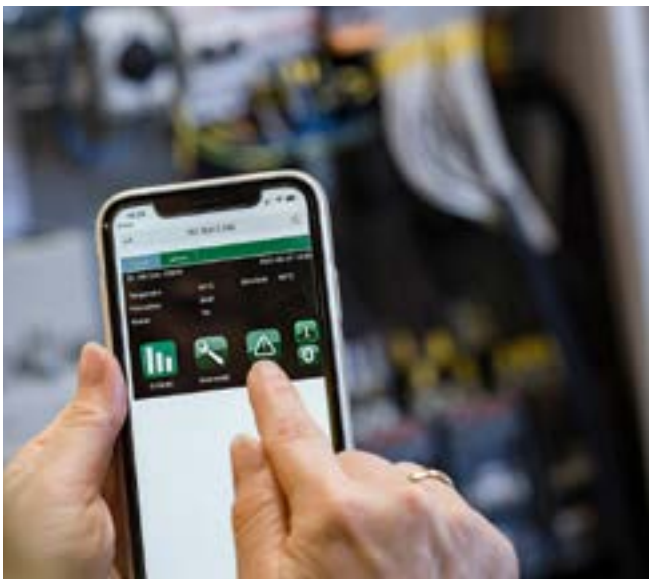

Water resistance

The boiler is made for ΔT 5 - 30 °C.

The chart to the right shows ΔT 5°C.

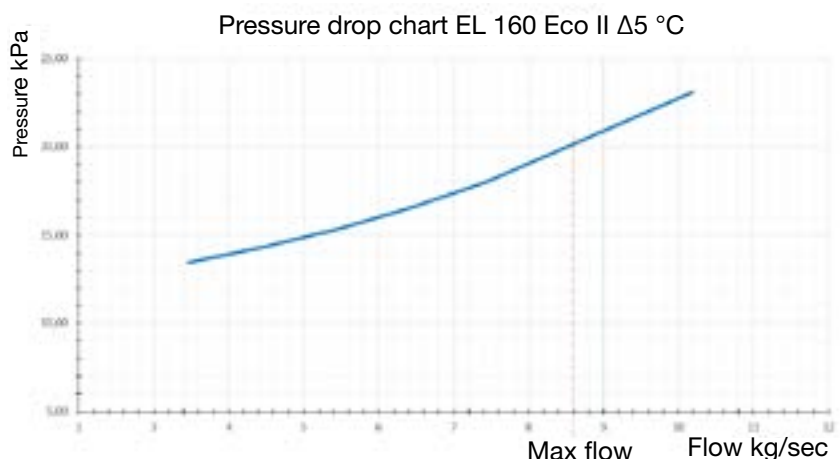

Osby Parca Electric Boilers Eco

Smart electric boilers 36 - 504 kW



Electric boilers with touchscreens and built-in safety equipment.

Osby Parca provides reputable electric boilers, complete with built-in safety equipment. A very reliable and convenient solution which is approved by a notified body. The electric boilers are often installed in combination with other heat sources, such as heat pumps and solid fuel boilers.

All of our electric boilers are equipped with a touchscreen as standard. The equipment provides ample installation possibilities for optimising operation, which allows for more reliable and economical use of the boiler.

The boilers are built around a pressure vessel with top-mounted immersion heaters and easily accessible connections for water supply and return lines, as well as drainage. The electrical equipment is installed behind a lockable hatch on the front of the boiler.

Common areas of use include radiator water heating in various types of facilities, and heating of process water in industrial environments.

Benefits of Osby Parca's electric boilers:

- Can be supplied with complete, built-in safety equipment.
- After a power outage that lasts for more than three minutes, boiler output connection is delayed for one hour in accordance with SEF's recommendations.
- Boiler output connection is regulated in stages (the number of stages can be limited to achieve lower power).
- The system's main fuse can be protected by installing current transformers and current sensors.
- The water temperature of the boiler can be regulated according to the preferred temperature (set point) or an external signal from e.g. a heat pump or outdoor sensor.
- Equipped with an overheat protection.
- Several boilers can be connected in parallel for a higher total output.
- Approved for zero flow.

Equipment Built-in safety system				
Boiler output	Designation	Connection	Opening pressure	Quantity
72 - 156 kW	Safety valve	DN 20/25	3 bar	1
	Max. pressure switch	DN 15		1
	Overheating protection/ Max. thermostat			1

NOTE! The safety equipment cannot be retrofitted!

Accessories Eco-series electric boilers		
Art. No.	Image	Designation
584196401	1	Outdoor temperature sensor incl. 15 m cable
1118404-01	2	3 current sensors for secondary measurement, max. 5A. Excl. current transformer
3364-3065	3	Cable flange FL21 1x16-300 mm ²
3364-3066	4	Cable flange FL 21 2x16-300 mm ²

Accessories:

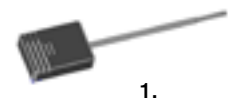

1.



2.



3.



4.

Dimensions & Connections EL160 Eco II Safety

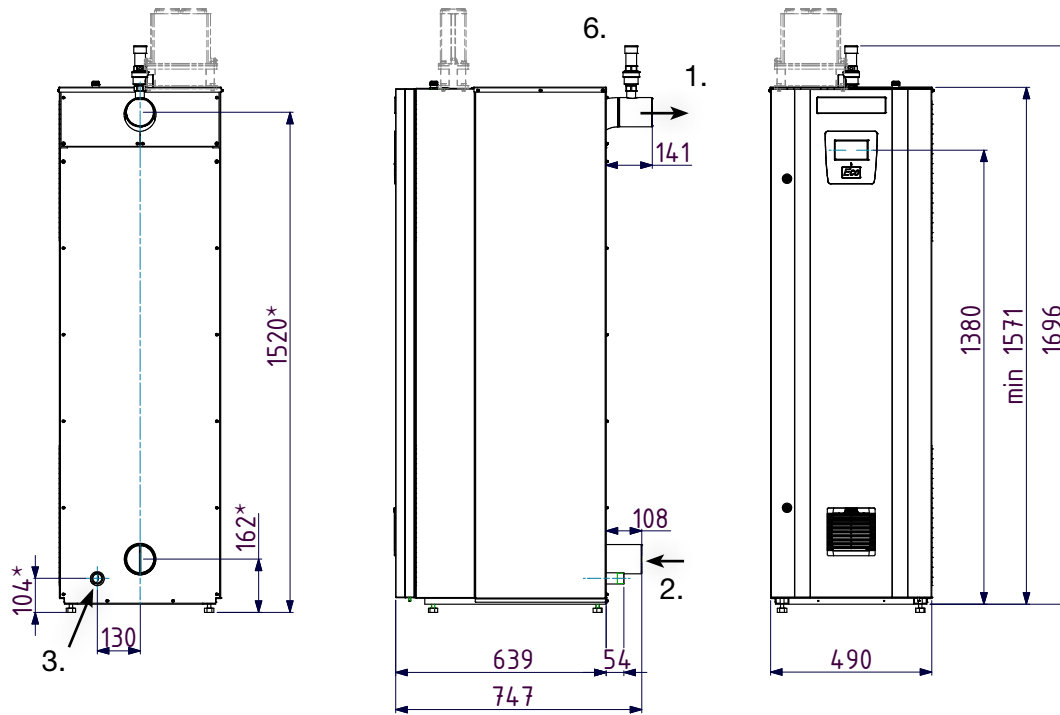

* Feet adjustable between about 12-35 mm

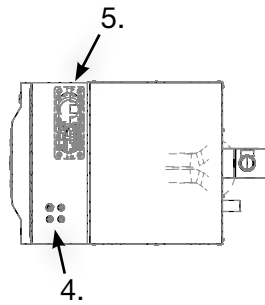

- | | |
|-----------------------|----------------------|
| 1. Supply flow | DN80 (threaded ext.) |
| 2. Return flow | DN80 (threaded ext.) |
| 3. Drainage | R1" ext. |
| 4. Connection slot | 4 x PG11 |
| 5. Flange opening | 1 pc. FL-21 |
| 6. Safety valve 3 bar | DN 20/25 (Only in S) |

Minimum distance of 900 mm between boiler top and inner ceiling.

Separate power supply 230 V 1 ~ required for operating voltage.

NOTE! Pipe connections do NOT have dimensions and C-C equal to Osby Parca EL 150.

Design data - EL 160 Eco II

Design pressure	6.0 bar
Testing pressure	8,6 bar
Design temperature	110 °C
Maximum operating temperature	100 °C
Boiler water volume	110 litres
Protection class	IP21
Cable connection	2 x 150 mm ²



Two threaded flanges are supplied on the side.

Art No 3632-0108

Dim: DN80, PN6, k=150 mm, D=190 mm

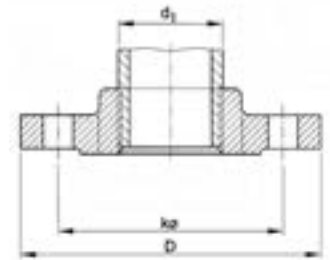

Technical data - EL 160 Eco II

Art. No.	Output		1:st Step	Steps	Voltage	Current	Weight (excl. water)	
	Std	S						kW
7700131	-01	-31	72	9	7	400 V	104	170-175
7700131	-02	-32	93	9	9	400 V	134	170-175
7700131	-03	-33	114	9	11	400 V	164	180-185
7700131	-04	-34	135	9	13	400 V	195	180-185
7700131	-05	-35	156	9	15	400 V	225	180-185